

RUNNER 250

QUICK START GUIDE

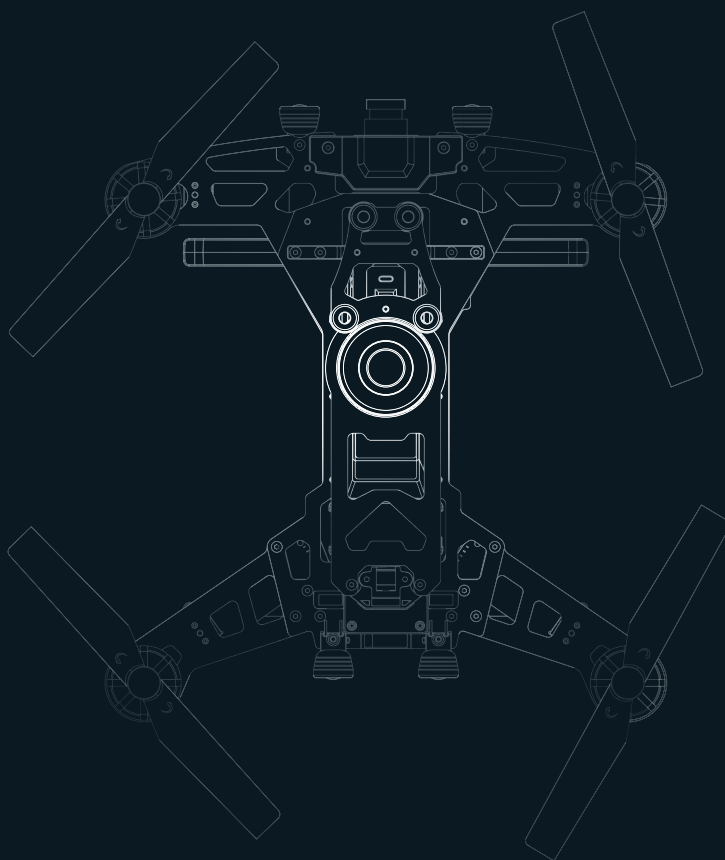

Contents

1.0 Get to know your aircraft	2
2.0 Specifications	3
3.0 Attention before flight	3
4.0 Charge the Battery	4
5.0 Assemble	4
6.0 Ready for flight	5
6.1 Binding of the Runner	5
6.2 Motor Unlock / Lock	5
7.0 Operation Instruction	6-7
8.0 End flight	7
9.0 Additional remark	8
9.1 DEVO F7 Radio Setting	8-9
9.2 DEVO 7 Radio Setting	10-11
9.3 TX5816(FCC)/TX5817(CE) emitter transmitting channel selection	11
9.4 Introduction for power plate	12
9.5 Blushless ESC and Blushless Motor connection schematic diagram	12
9.6 Instructions for GA005 balance charger	13

1.0 Get to know your aircraft

- Very strong and stable with carbon fiber frame.
- Support a 5.8Ghz video transmission system to get real time video.
- It is a modular design for electric components, easy for assemble and maintenance.
- It supports professional pilot to do 3D actions.

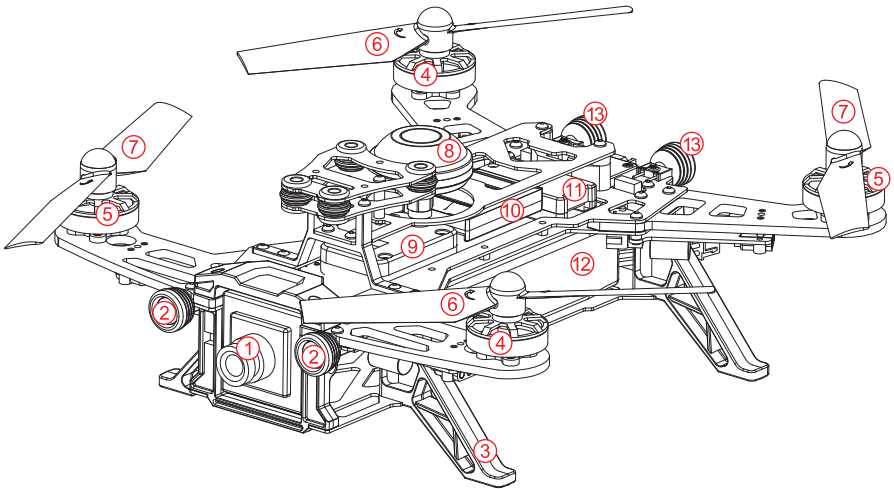

- | | |
|--|--|
| 1. Video Camera | 7. Counterclockwise propeller(black cap) |
| 2. White LED light | 8. Mushroom antenna |
| 3. Skid landing x 4 | 9. TX5816(FCC)/TX5817(CE) emitter |
| 4. Clockwise motor (levogyrate thread is counterclockwise) | 10. FCS-RUNNER 250 Main Controller |
| 5. Counterclockwise motor (dextrogyrate thread is clockwise) | 11. DEVO-RX710 Receiver |
| 6. Clockwise propeller (white cap) | 12. Battery: 11.1V 2200mAh 25C 3S Li-Po |
| | 13. Red LED light |

2.0 Specifications

● Aircraft specifications

Main Rotor Dia.: 140mm

Overall (L x W x H): 225 x 205 x 92mm

Weight: 530g (Battery included)

Transmitter: DEVO F7/DEVO 7

Receiver: DEVO-RX710

Main Controller: FCS-RUNNER 250

Emitter: TX5816(FCC)/TX5817(CE)

Brushless Motor: WK-WS-28-014(CW/CCW)

Brushless ESC: RUNNER 250

Battery: 11.1V 2200mAh 25C 3S LiPo

Flight Time: 12~14mins

Working temperature: -10°C ~ +40°C

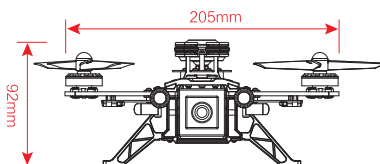
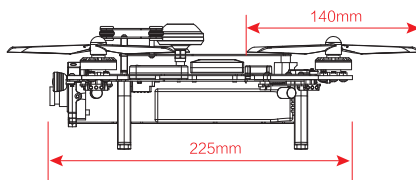

● Video Camera specifications

Horizontal Resolution: 800TVL

System Committee: PAL/NTSC

Video Out: 1.0Vp-p/75Ω

Power Input: DC 12V

3.0 Attention before flight

- (1) This product is suitable for people who has flight experience of hobby model and ages 14+.
- (2) Do not fly in bad weather, such as windy, snowy, foggy etc..
- (3) Choose open, legal field to fly.
- (4) Please keep away from highly spinning parts(such as propellers and motors).
- (5) Do not fly it in where there is high-voltage lines, communication base stations or radio towers, in order to avoid signal interference.
- (6) Don't fly in no-fly zone according to the local laws and regulations.

4.0 Charge the Battery

① Insert the power adapter(100~240V 50/60HZ),connect the output end to the GA005 balance charger, the balance charger is red LED at this time.

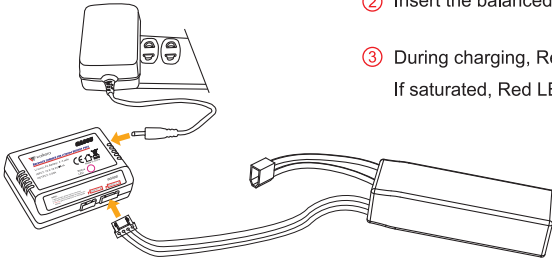

Charging jack for 11.1V battery

② Insert the balanced pin of LiPo battery into GA005.

③ During charging, Red LED is continuously flashing. If saturated, Red LED becomes solid green lighting.

⚠ Please refer to Page 13 for details of GA005 balance charger.

5.0 Assemble

● Install propellers

Fix the clockwise propeller(white cap) onto the clockwise motor according to the direction of arrow, and fix the counterclockwise propeller(black cap) on the counterclockwise motor according to the direction of arrow. Tighten the propellers manually and make sure the propeller is installed in proper way and fastened.

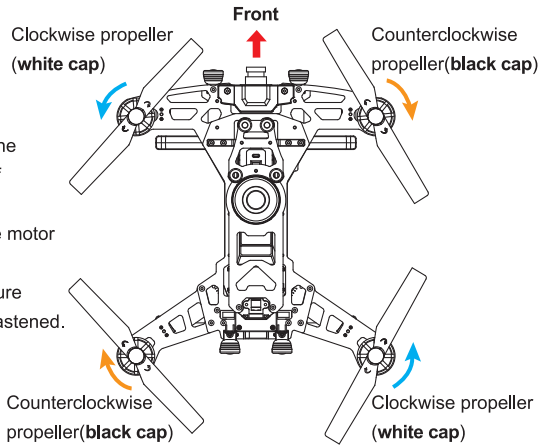

● Battery installation

Put the Lipo battery into the body, and fix it with belt.

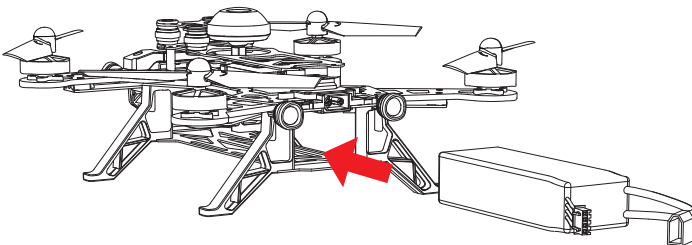

6.0 Ready for flight

6.1 Binding of the Runner 250

- ① Put all the function switches to the 0 position, put all trims/knobs to the Middle position, move the throttle to the lowest position, then turn on the radio.
- ② Put the aircraft in horizontal position, then connect the aircraft power.
- ③ After 5 sec. the red LED light will stop flashing indicating that the code binding has finished.

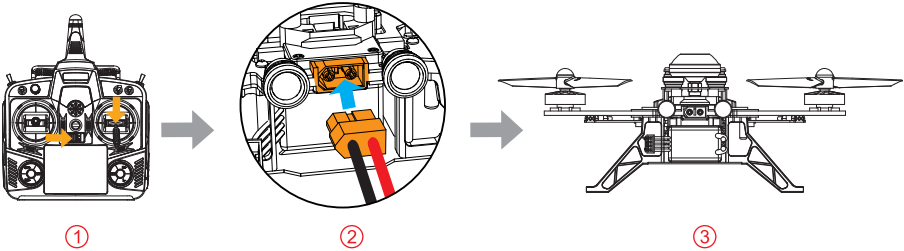

6.2 Motor Unlock / Lock

● Motor Unlock

After binding the DEVO F7/DEVO 7 to the Runner 250, Check that all trims are neutral, the throttle stick is ALL the way Down with the display indicating 0% throttle. Check that ALL switches are in the UP position. Gently push the throttle stick down and move the rudder (YAW) stick to the left side.

(on mode 2 radios throttle and rudder is the same stick)

You will see the RED LED light turn on, indicating that motors are unlocked.

Be very careful at this point, as pushing the throttle up will start the motors. You can test by pushing the stick up a little, the motors should start.

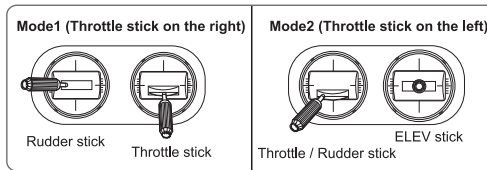

● Motor Lock







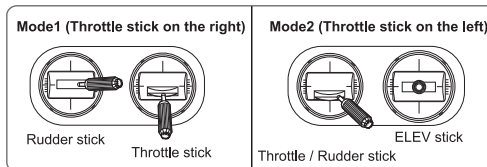

Lock the motors by moving the throttle stick all the way down and the rudder (YAW) stick all the way to the right. The RED LED light will go out when the motors are disarmed.

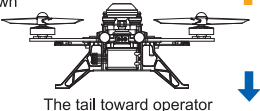
TEST: Push the throttle stick up a little, the motors will not start when locked.

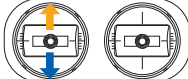
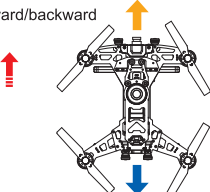
NOTICE: The motors are LOCKED by default after successful binding.

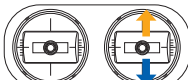
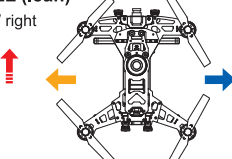
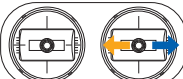
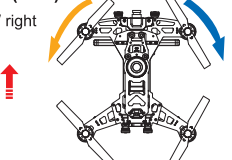
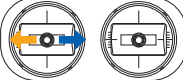

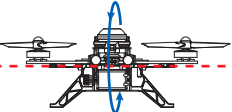
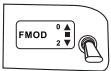
7.0 Operation Instruction

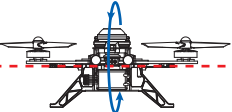
Model (← is the nose direction)	Mode1 (Throttle stick on the right)	Mode2 (Throttle stick on the left)
<p>THROTTLE Up/down</p>  <p>The tail toward operator</p>		
<p>PITCH Forward/backward</p> 		
<p>ROLL (lean) Left / right</p> 		
<p>YAW (turn) Left / right</p> 		
<p>The aircraft roll forward</p>  <p>The tail toward operator</p> <hr/> <p>The aircraft roll backward</p>  <p>The tail toward operator</p>	 <p>Put the FMOD(FMD) switch to "2" position</p> <div style="display: flex; justify-content: space-around;"> <div data-bbox="644 1149 791 1268">  <p>Mode1 (Throttle stick on the right)</p> </div> <div data-bbox="802 1149 955 1268">  <p>Mode2 (Throttle stick on the left)</p> </div> </div> <p>Attention:</p> <ol style="list-style-type: none"> (1) Please select a larger space,soft ground for flying. (2) The rolling mode is more suitable for experienced pilots. (3) Need match the throttle for practice during the rolling,when the aircraft drop please up throttle a bit, when the aircraft rise please down the throttle a little. (4) When the voltage is low, the aircraft switched automatically from roll mode to normal mode 	

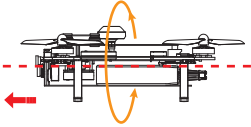
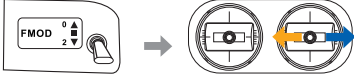
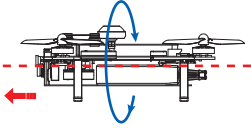
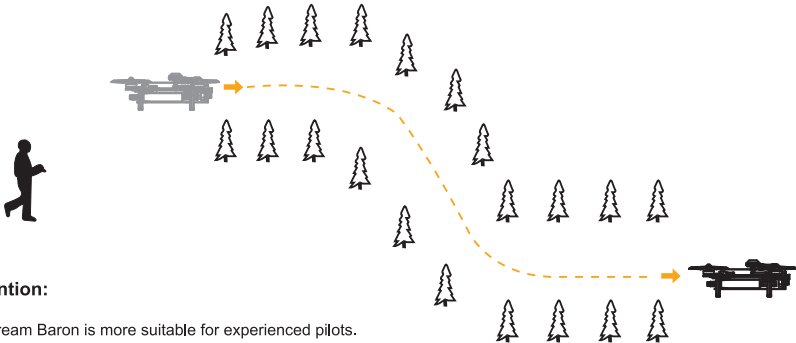
Model (← is the nose direction)	Radio
<p>The aircraft roll left</p> 	 <p>Put the FMOD(FMD) switch to "2" position</p> <p>Mode1 (Throttle stick on the right) Mode2 (Throttle stick on the left)</p>
<p>The aircraft roll right</p> 	<p>Attention:</p> <ol style="list-style-type: none"> (1) Please select a larger space, soft ground for flying. (2) The rolling mode is more suitable for experienced pilots. (3) Need match the throttle for practice during the rolling, when the aircraft drop please up throttle a bit, when the aircraft rise please down the throttle a little. (4) When the voltage is low, the aircraft switched automatically from roll mode to normal mode
<p>Dream Baron</p>  <p>Attention:</p> <ol style="list-style-type: none"> (1) Dream Baron is more suitable for experienced pilots. (2) During the flying, please keep in sight of 50 meters or video control range within 300 meters to control the flight.(Actual range depending on the flight environment and weather conditions.) (3) During the flying, please avoid obstacles such as people, animals and power lines. 	

 **When the red LED light behind the aircraft flashes slowly, the voltage of the battery is too low.**

8.0 End flight

- ① Manual landing.
- ② First, power off aircraft battery, then power off radio battery.
- ③ Take the battery out of aircraft.

9.0 Additional remark

9.1 DEVO F7 Radio Setting

● Boot Screen(Main interface)

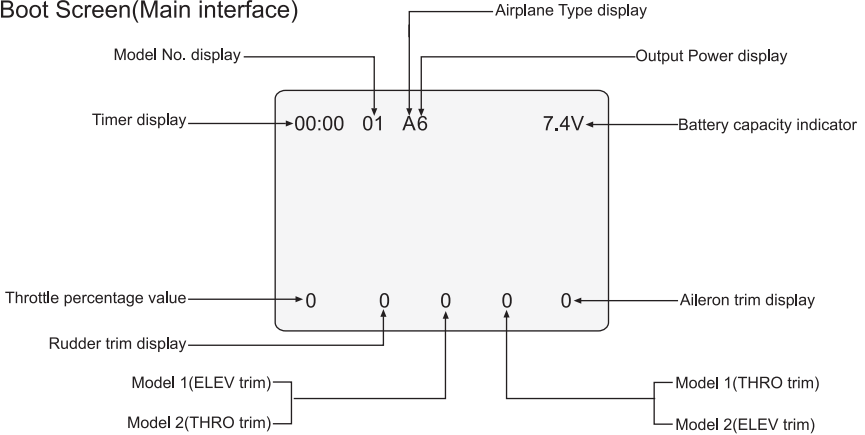

● Model Select

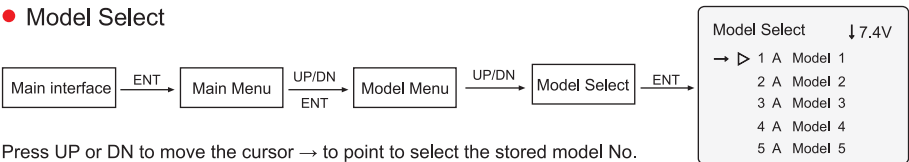

Press UP or DN to move the cursor → to point to select the stored model No.

For example "Model 1", press ENT to confirm and then press EXT to return to Model Menu.

● Model Name

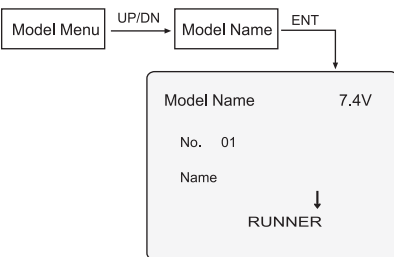

Press UP or DN to move the cursor → to point to select the character and figure which need to be changed, press R or L button to change the character and figure, name model as RUNNER. Press ENT to confirm and then press EXT to return to Model Menu.

● Type Select

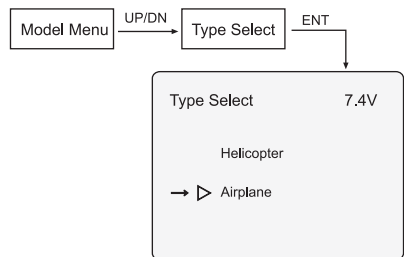

Press UP or DN to move the cursor → to point to Airplane option. Press ENT to confirm and then press EXT to return to Model Menu.

● Wing Type

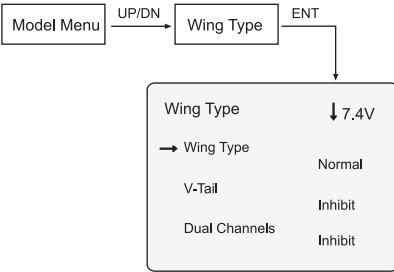

Press UP or DN to move the cursor → to point to Wing Type option, press R or L to select "Normal". Press ENT to confirm and then press EXT to return to Model Menu.

● Device Output

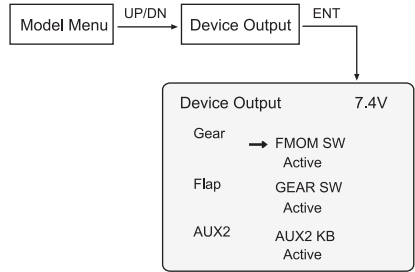

After finish settings, press ENT to confirm and then press EXT to return to Main Menu.

● Reverse Switch

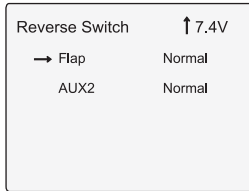
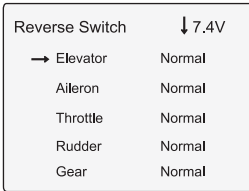

Press R or L to select Normal.
After finish settings, press ENT to confirm and then press EXT to return to Main Menu.

● Video Setting and OSD information(OSD module should be purchased)

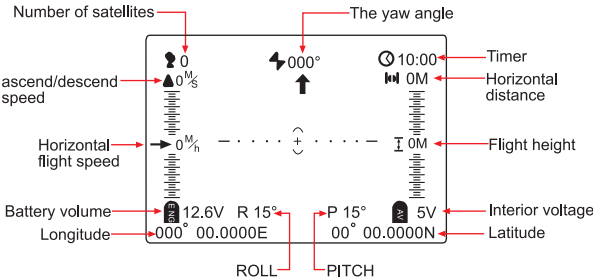
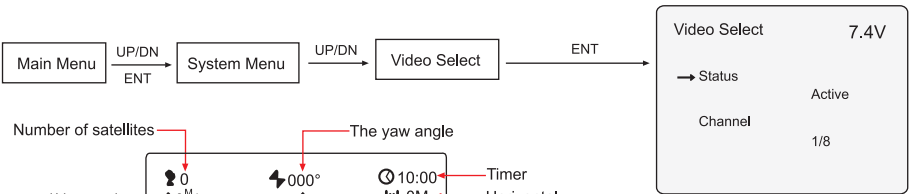

Status: Press R or L to select "Active".

Channel: Press R or L to select suitable receiving video channel for the TX5816/TX5817. It will display automatically "OSD" after connection.

After finish settings, press ENT to confirm and then press EXT to return to Main interface.

! Slide the video switch and OSD module code switch "1" to "ON", please refer to page 12.

9.2 DEVO 7 Radio Setting

● Boot Screen(Main interface)

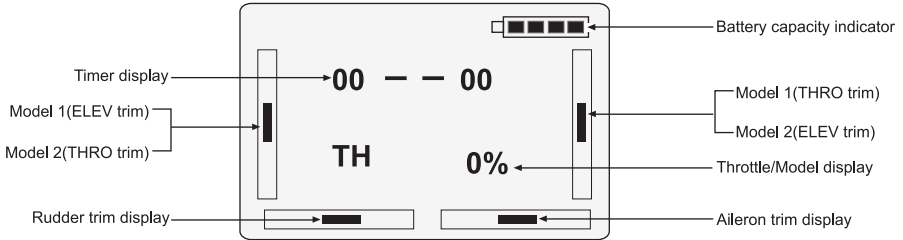

● SELEC

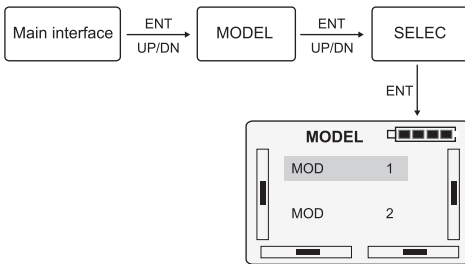

Press UP or DN to select "MOD 1", press ENT to confirm and then press EXT to return to MODEL.

● NAME

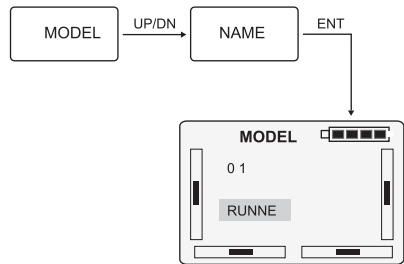

Press R or L button to change the character and figure, named model as RUNNE. Press ENT to confirm and then press EXT to return to MODEL.

● TYPE

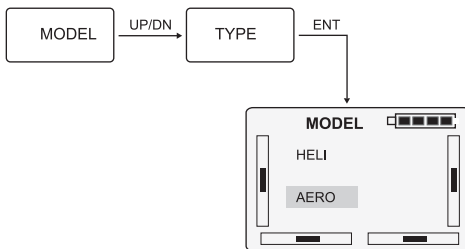

Press UP or DN to select AERO, Press ENT to confirm and then press EXT to return to MODEL.

● WING

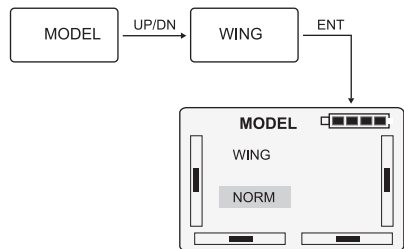

Press R or L to select NORM, Press ENT to confirm and then press EXT to return to MODEL.

● OUTPUT

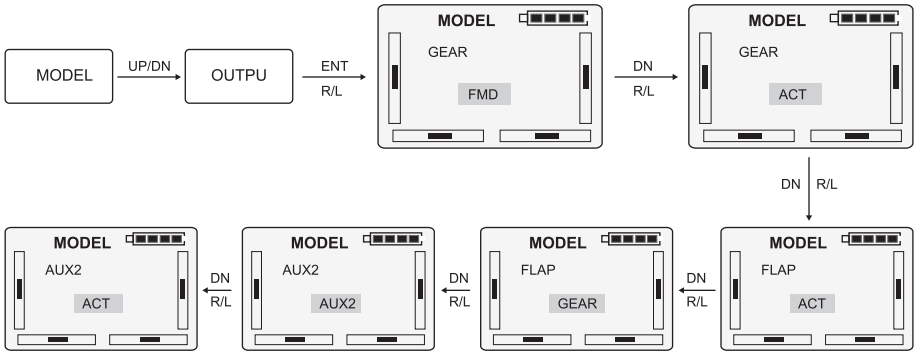

After finish settings, press ENT to confirm and then press EXT to return to Main interface.

● REVSU

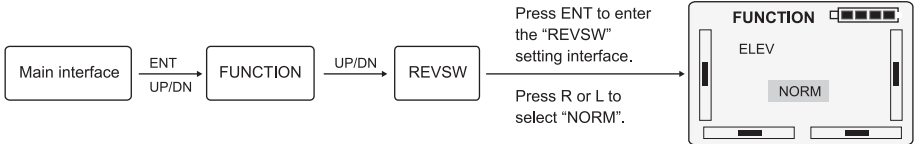

ELEV	AILE	THRO	RUDD	GEAR	FLAP	AUX2
NORM	NORM	NORM	NORM	NORM	NORM	NORM

After finish settings, press ENT to confirm and then press EXT to return to Main interface.

9.3 TX5816(FCC)/TX5817(CE) emitter transmitting channel selection

There are 8 different channels can be selected. You can choose the best frequency channel according to the image quality as below:

Channel	1	2	3	4	5	6	7	8
Frequency	5866MHz	5847MHz	5828MHz	5809MHz	5790MHz	5771MHz	5752MHz	5733MHz
Code position (on/off)								

Note: (1) Only transmitting channels 2, 4, 6, 8 are available for the TX5816(FCC) emitter.

(2) Transmitting channel and video receiving channel must be correspondent with each other.

9.4 Introduction for power plate

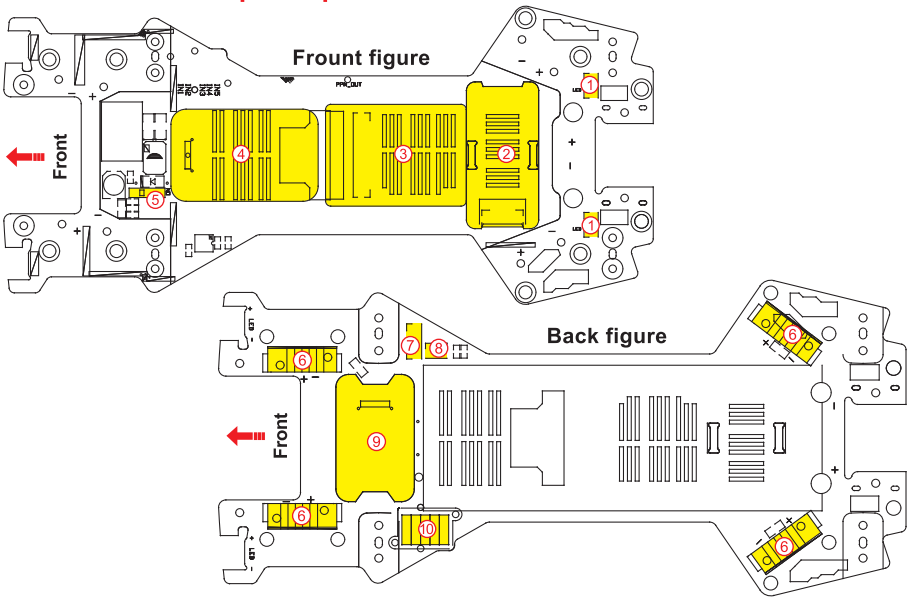

- 1.Red LED connection port
- 2. DEVO-RX710 Receiver install position
- 3. FCS-RUNNER 250 Main Controller install position
- 4. TX5816(FCC) or TX5817(CE) emitter install position
- 5. Video Switch: ON Slide the switch to "ON" to start the video
- 6. Brushless ECS connect position
- 7. Camera connect Port: (5 pins/5V)
- 8. Camera connect Port: (3 pins/11.1V)
- 9. OSD module install position (ON / 1 / 2 slide the code switch "1" to "on" to start the OSD)
- 10. Extra receiver connect port

9.5 Brushless ESC and Brushless Motor connection schematic diagram

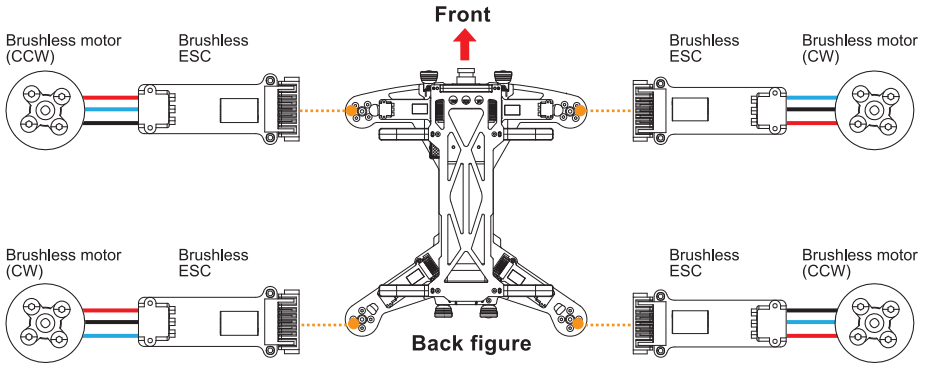

9.6 Instructions for GA005 balance charger

● Parameters of GA005 balance charger

Input voltage	Input current	Output current	Dimension	Weight
DC15-18V	1000mA	≤800mA	62.5 x 47 x 20.8mm	46g

● Features of GA005 balance charger

- (1) GA005 utilizes microcomputer chips to monitor and control over the whole charging process in a balanced way with LED indicator to display the charging status at real time.
- (2) Connects to an input power supply (DC 15-18V 1000 mA).
- (3) GA005 is suitable for 7.4V/ 11.1V Li-ion or Li-polymer battery pack.
- (4) GA005 can detect Li-Po battery automatically. GA005 will automatically charge when it finds the voltage of single cell battery is excessively low. At the same time LED displays as charging status (flash in red). Control single cell battery voltage at the range of 4.2 ±0.05V to ensure the maximum voltage difference of single cell in the battery is less than 50 mV.

● Instruction of GA005 balance charger

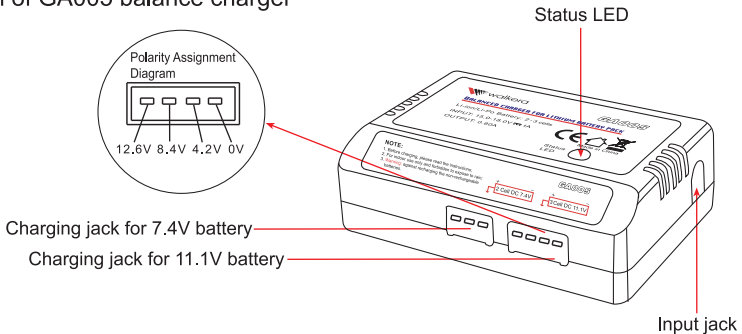

● Matters needing attention

- (1) GA005 is only used to charging a 2S or 3S Li-ion or Li-polymer battery. It is forbidden to simultaneously charge two or more sets of batteries. Either the charger or battery may be damaged.
- (2) During charging, GA005 should be put in dry and ventilated place and be far away from heat sources and inflammable and explosive substances.
- (3) When charging, the battery should be removed from your helicopter. Never leave the charger unsupervised during the process of charging in order to avoid risk of accidents.
- (4) Never immediately charge your battery as soon as the flight is finished, or when its temperature doesn't cool down. Otherwise the battery will take a risk in swelling, even a fire.
- (5) Ensure the correctness of polarity before connecting the battery to charger.
- (6) Avoid drop and violence during the process of charging. Drop and violence will result in internal short circuit of the battery.
- (7) For the sake of safety, please use original charging equipment (wall adapter + GA005 balance charger) and battery. Please change new one in time when the old battery pack is becoming swollen due to long time usage.
- (8) If it is retained in the charger for a long time after saturated, the battery may automatically discharge. When the charger detects that the voltage of individual cells is lower than the rated voltage, it will re-charge until saturated. Frequently charging and discharging will shorten the lifetime of your battery.

Tel.: (8620) 8491 5115 8491 5116

Fax.: (8620) 8491 5117

Email: heli@walkera.com
info@walkera.com

Add.: Taishi Industrial Park, Dongchong Town
nansha District, 511475 Guangzhou



Specifications, contents of parts and availability are subject to change, Walkera is not responsible for inadvertent errors in this publication.



Web: www.walkera.com